

ULTRA LOW CAPACITANCE STEERING DIODE ARRAY



DESCRIPTION

The ET721 is a low capacitance and low leakage steering diode array capable of protecting up to six (6) high speed data lines. Its ultra low capacitance allows maintenance of signal integrity for high-speed data lines while protecting the circuit ICs from the damage of severe transients. An extremely low leakage current makes the ET721 suitable for battery powered devices.

The ET721 is available in a SO-8 package. This device meets all the applicable voltage immunity standards, including IEC 61000-4-2 (ESD), 61000-4-4 (EFT) and 61000-4-5 (Surge).

FEATURES

- Compatible with IEC 61000-4-2 (ESD): Air - 15kV, Contact - 8kV
- Compatible with IEC 61000-4-4 (EFT): 40A - 5/50ns
- Compatible with IEC 61000-4-5 (Surge): 12A, 8/20 μ s - Level 1(Line-Gnd) & Level 2(Line-Line)
- Low Clamping Voltage
- Provides Six Lines of Protection
- Low Leakage Current: <200nA
- Ultra Low Capacitance: 3pF Typical
- RoHS Compliant
- REACH Compliant

APPLICATIONS

- Ethernet 10/100/1000 Base T
- SMART Phones
- Set-Top Box Interface
- FireWire & USB Interfaces
- Sensors

MECHANICAL CHARACTERISTICS

- Molded JEDEC SO-8 Package
- Approximate Weight: 70 milligrams
- Lead-Free Pure-Tin Plating (Annealed)
- Solder Reflow Temperature:
Pure-Tin - Sn, 100: 260-270°C
- 12mm Tape and Reel Per EIA Standard 481
- Flammability Rating UL 94V-0

PIN CONFIGURATION

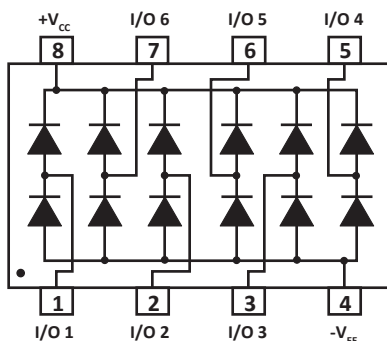

TYPICAL DEVICE CHARACTERISTICS
MAXIMUM RATINGS @ 25°C Unless Otherwise Specified

| PARAMETER | SYMBOL | VALUE | UNITS |
|------------------------------|-----------|------------|-------|
| Operating Temperature | T_A | -55 to 150 | °C |
| Storage Temperature | T_{STG} | -55 to 150 | °C |
| Continuous Power Dissipation | P_{PC} | 145 | mW |

ELECTRICAL CHARACTERISTICS PER LINE @ 25°C Unless Otherwise Specified

| PART NUMBER | DEVICE MARKING | REPETITIVE PEAK REVERSE VOLTAGE (Note 1) V_{RRM} VOLTS | TYPICAL FORWARD VOLTAGE 8/20 μ s @ 1A V_F VOLTS | MAXIMUM PEAK PULSE FORWARD CURRENT @ 8/20 μ s I_{FM} AMPS | MAXIMUM REVERSE LEAKAGE CURRENT (Note 2) V_{RRM} I_R nA | MAXIMUM QUIESCENT SUPPLY CURRENT (Note 3) @ 20V I_{RQ} nA | TYPICAL CAPACITANCE 0V, 1MHz C_J pF |
|-------------|----------------|--|---|--|--|--|--|
| ET721 | STA | 50 | 2 | 12 | 20 | 200 | 3 |

NOTE

- V_{RRM} is $+V_{CC}$ for pin 8, $-V_{EE}$ for pin 4.
- +20V from pin 8 to 1, 2, 3, 5, 6 and 7. -20V from pin 4 to 1, 2, 3, 5, 6 and 7.
- +20V from pin 8 to 4.

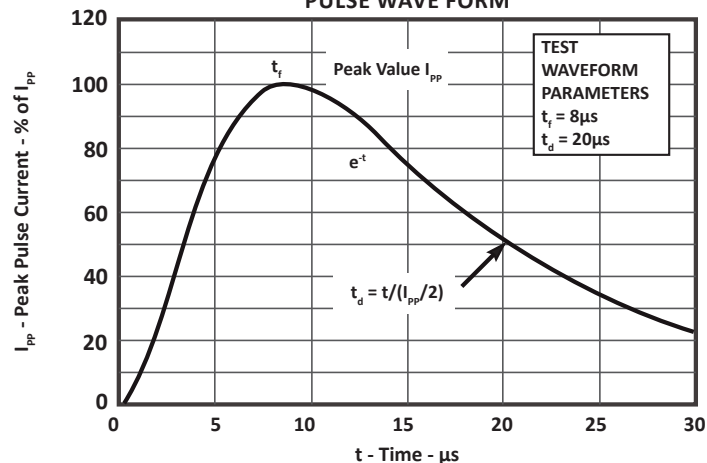
**FIGURE 1
PULSE WAVE FORM**

TYPICAL DEVICE CHARACTERISTICS

FIGURE 2
NON-REPETITIVE PEAK PULSE CURRENT CAPABILITY

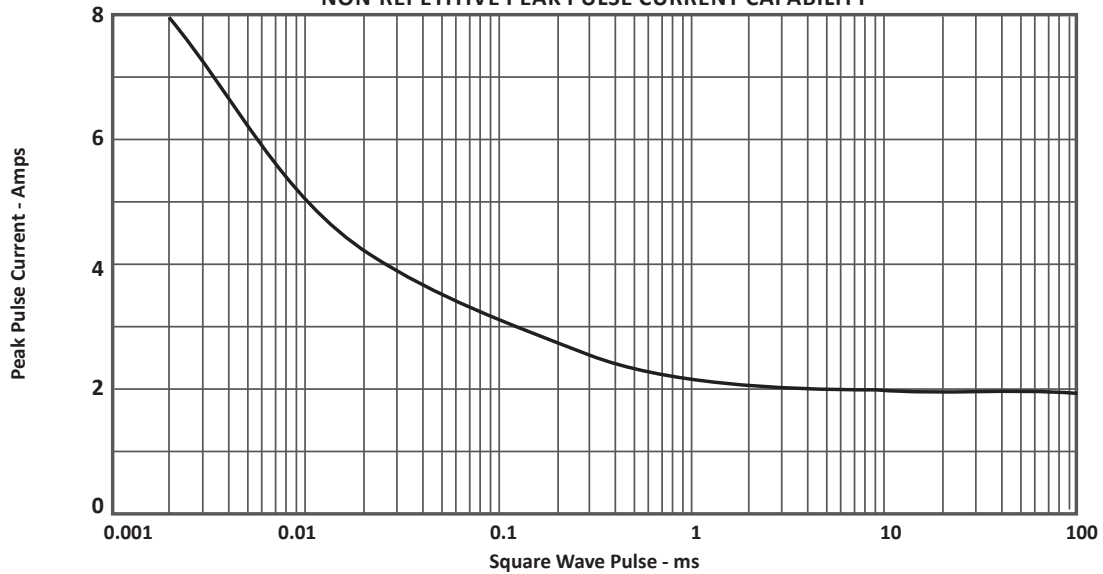

FIGURE 3
TYPICAL LOW CURRENT FORWARD VOLTAGE DROP

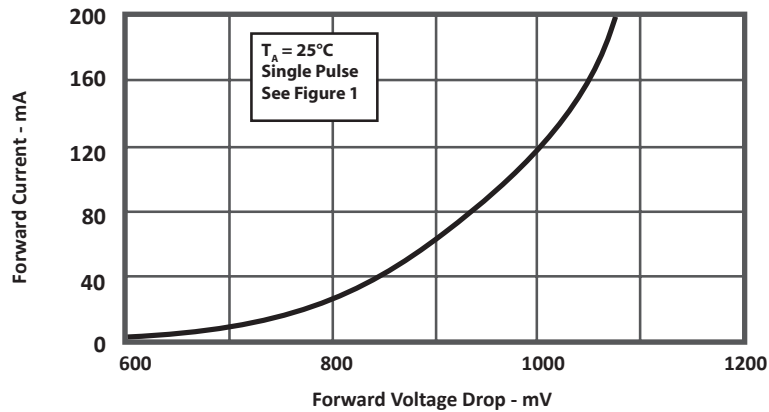
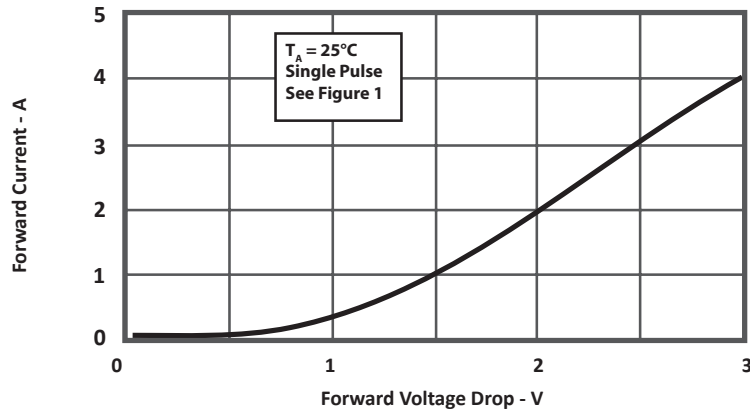
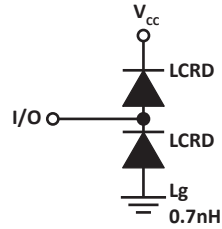

FIGURE 4
LOW FORWARD CURRENT VS FORWARD VOLTAGE



SPICE MODEL

FIGURE 1
SPICE MODEL



LCRD - Low Capacitance Rectifier Diode
 Lg - Lead Inductance

| TABLE 1 - SPICE PARAMETERS | | |
|----------------------------|---------------|-------|
| PARAMETER | UNIT | LCRD |
| BV | V | 200 |
| IBV | μA | 0.01 |
| C_{jo} | pF | 3 |
| I_s | A | 1E-13 |
| Vj | V | 0.6 |
| M | - | 0.33 |
| N | - | 1 |
| R_s | Ohms | 0.31 |
| TT | s | 1E-9 |
| EG | eV | 1.11 |

SO-8 PACKAGE INFORMATION

OUTLINE DIMENSIONS

| DIM | MILLIMETERS | | INCHES | |
|-----|-------------|------|----------|-------|
| | MIN | MAX | MIN | MAX |
| A | 4.80 | 5.00 | 0.189 | 0.196 |
| B | 3.80 | 4.00 | 0.150 | 0.157 |
| C | 1.35 | 1.75 | 0.054 | 0.068 |
| D | 0.35 | 0.49 | 0.014 | 0.019 |
| F | 0.40 | 1.25 | 0.016 | 0.049 |
| G | 1.27 BSC | | 0.05 BSC | |
| J | 0.18 | 0.25 | 0.007 | 0.009 |
| K | 0.10 | 0.25 | 0.004 | 0.008 |
| P | 5.80 | 6.20 | 0.229 | 0.244 |
| R | 0.25 | 0.50 | 0.010 | 0.019 |

NOTES

- T = Seating plane and datum surface.
- Dimensions "A" and "B" are datum.
- Dimensions "A" and "B" do not include mold protrusion.
- Maximum mold protrusion is 0.015" (0.380mm) per side.
- Dimensioning and tolerances per ANSI Y14.5M, 1982.
- Dimensions are exclusive of mold flash and metal burrs.

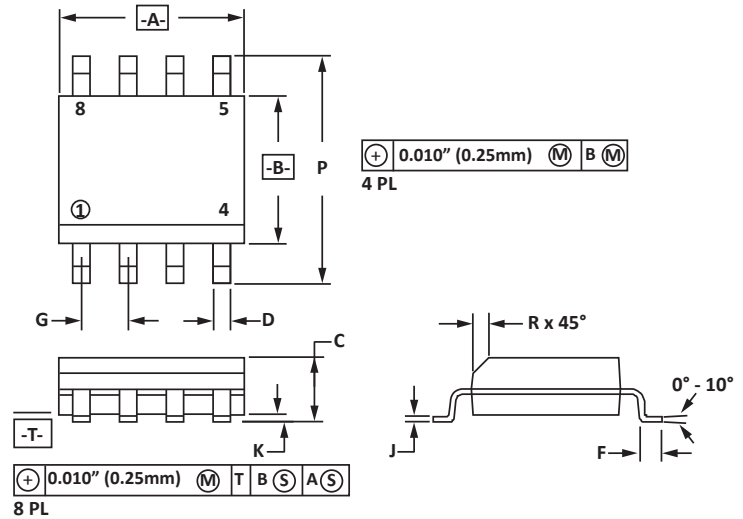

PAD LAYOUT DIMENSIONS

| DIM | MILLIMETERS | | INCHES | |
|-----|-------------|------|--------|-------|
| | MIN | MAX | MIN | MAX |
| A | 1.14 | 1.40 | 0.045 | 0.055 |
| B | 0.64 | 0.89 | 0.025 | 0.035 |
| C | 6.22 | - | 0.245 | - |
| D | 3.94 | 4.17 | 0.155 | 0.165 |
| E | 1.02 | 1.27 | 0.040 | 0.050 |

NOTES

- Controlling dimension: inches.

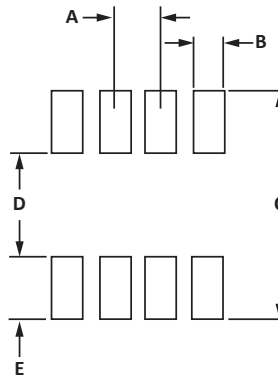

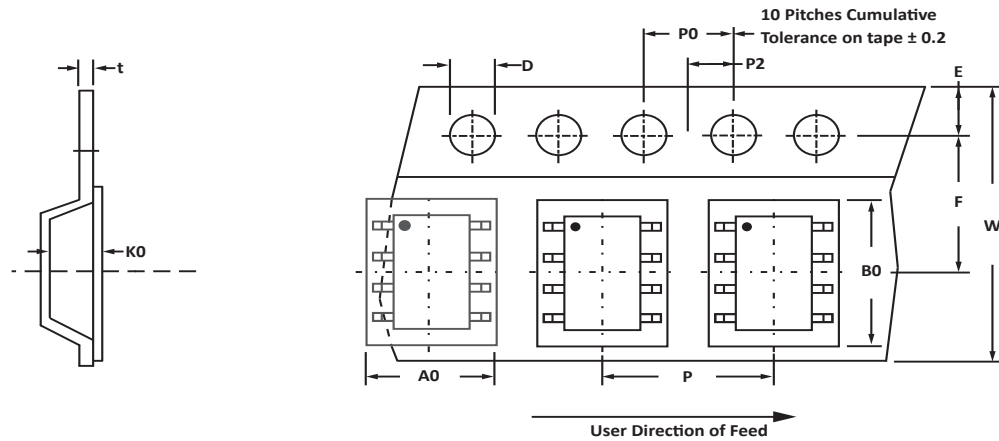
TAPE AND REEL

SPECIFICATIONS

| REEL DIA. | TAPE WIDTH | A0 | B0 | K0 | D | E | F | W | P0 | P2 | P | tmax |
|------------|------------|-------------|-------------|-------------|-------------|-------------|-------------|--------------|-------------|-------------|-------------|------|
| 178mm (7") | 12mm | 6.50 ± 0.10 | 5.40 ± 0.10 | 2.00 ± 0.10 | 1.50 ± 0.10 | 1.75 ± 0.10 | 5.50 ± 0.05 | 12.00 ± 0.30 | 4.00 ± 0.12 | 2.00 ± 0.10 | 8.00 ± 0.10 | 0.25 |

NOTES

- Dimensions are in millimeters.
- Surface mount product is taped and reeled in accordance with EIA-481.
- Suffix - T7 = 7" Reel - 1,000 pieces per 12mm tape.
- Suffix - T13 = 13" Reel - 2,500 pieces per 12mm tape.
- Bulk product shipped in tubes of 98 pieces per tube.
- Marking on Part - marking code (see page 2), date code, logo and pin one defined by dot on top of package.

ORDERING INFORMATION

| BASE PART NUMBER | LEADFREE SUFFIX | TAPE SUFFIX | QTY/REEL | REEL SIZE | TUBE QTY |
|------------------|-----------------|-------------|----------|-----------|----------|
| ET721 | -LF | -T7 | 1,000 | 7" | 98 |
| ET721 | -LF | -T13 | 2,500 | 13" | 98 |

This device is only available in a Lead-Free configuration.

COMPANY INFORMATION

COMPANY PROFILE

In business more than 25 years, ProTek Devices™ is a privately held semiconductor company. The company offers a product line of overvoltage protection and overcurrent protection components. These include transient voltage suppressor array (TVS arrays) avalanche breakdown diode, steering diode TVS array and electronics SMD chip fuses. These components deliver circuit protection in electronic systems from numerous overvoltage and overcurrent events. They include lightning; electrostatic discharge (ESD); nuclear electromagnetic pulses (NEMP); inductive switching; and electromagnetic interference (EMI) / radio frequency interference (RFI). ProTek Devices also offers LED wafer die for ESD protection and related high frequency products. ProTek Devices is ISO 9001:2015 certified.

CONTACT US

Corporate Headquarters

2929 South Fair Lane
Tempe, Arizona 85282
USA

By Telephone

General: 602-431-8101
Sales: & Marketing: 602-414-5109
Customer Service: 602-414-5114
Product Technical Support: 602-414-5107

By Fax

General: 602-431-2288

By E-mail:

Asia Sales: asiasales@protekdevices.com
Europe Sales: europesales@protekdevices.com
U.S. Sales: ussales@protekdevices.com
Distributor Sales: distysales@protekdevices.com
Customer Service: service@protekdevices.com
Technical Support: support@protekdevices.com

ProTek Devices (Asia Pacific) Pte. Ltd.

8 Ubi Road 2, #06-19
Zervex
Singapore - 408538
Tel: +65-67488312
Fax: +65-67488313

Web

www.protekdevices.com

COPYRIGHT © ProTek Devices 2001 - This literature is subject to all applicable copyright laws and is not for resale in any manner.

SPECIFICATIONS: ProTek reserves the right to change the electrical and or mechanical characteristics described herein without notice.

DESIGN CHANGES: ProTek reserves the right to discontinue product lines without notice and that the final judgement concerning selection and specifications is the buyer's and that in furnishing engineering and technical assistance. ProTek assumes no responsibility with respect to the selection or specifications of such products. ProTek makes no warranty, representation or guarantee regarding the suitability of its products for any particular purpose, nor does ProTek assume any liability arising out of the application or use of any product or circuit and specifically disclaims any and all liability without limitation special, consequential or incidental damages.

LIFE SUPPORT POLICY: ProTek Devices products are not authorized for use in life support systems without written consent from the factory.