

ULTRA LOW CAPACITANCE TVS ARRAYS



SOD-323 PACKAGE

DESCRIPTION

The PAM02SD23xx/C Series are ultra low capacitance transient voltage suppressor arrays, designed to protect automotive applications. These devices are available in either a unidirectional or bidirectional configuration and are rated at 350 Watts for an 8/20 μ s waveshape.

The PAM02SD23xx/C Series meets IEC 61000-4-2 (ESD) and IEC 61000-4-4 (EFT) requirements. At higher operating frequencies or faster edge rates, insertion loss and signal integrity are a major concern. These devices are ultra low capacitance and low leakage current in a miniature SOD-323 package.

FEATURES

- **AEC-Q101 Qualified**
- Compatible with IEC 61000-4-2 (ESD): Air ± 15 kV, Contact ± 8 kV
Exceeds Level 4: Handles 10kV Contact & 25kV Air Discharge
- Compatible with IEC 61000-4-4 (EFT): 40A - 5/50ns
- Compatible with IEC 61000-4-5 (Surge)
- 350 Watts Peak Pulse Power per Line ($t_p = 8/20\mu s$)
- Replacement for MLV (0805)
- Unidirectional and Bidirectional Configurations
- Protects One Power or I/O Port
- Available in Multiple Voltages
- ESD Protection > 25kV
- Low Clamping Voltage
- Ultra Low Capacitance: 3pF (Typical)
- RoHS Compliant
- REACH Compliant

APPLICATIONS

- Automotive Applications

MECHANICAL CHARACTERISTICS

- Molded JEDEC SOD-323 Package
- Approximate Weight: 5 milligrams
- Lead-Free Pure-Tin Plating (Annealed)
- Solder Reflow Temperature:
Pure-Tin - Sn, 100: 260-270°C
- 8mm Tape and Reel Per EIA Standard 481
- Flammability Rating UL 94V-0

PIN CONFIGURATIONS

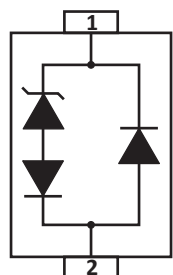

UNIDIRECTIONAL

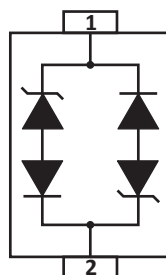

BIDIRECTIONAL

TYPICAL DEVICE CHARACTERISTICS
MAXIMUM RATINGS @ 25°C Unless Otherwise Specified

PARAMETER	SYMBOL	VALUE	UNITS
Peak Pulse Power (tp = 8/20μs) - See Figure 1	P_{PP}	350	Watts
Operating Temperature	T_A	-55 to 150	°C
Storage Temperature	T_{STG}	-55 to 150	°C

ELECTRICAL CHARACTERISTICS PER LINE @ 25°C Unless Otherwise Specified

PART NUMBER	DEVICE MARKING	RATED STAND-OFF VOLTAGE	MINIMUM BREAKDOWN VOLTAGE	MAXIMUM CLAMPING VOLTAGE (Fig. 2)	MAXIMUM LEAKAGE CURRENT	TYPICAL CAPACITANCE
		V_{WM} VOLTS	@ 1mA $V_{(BR)}$ VOLTS	@ IP = 1A V_C VOLTS	@ V_{WM} I_D μA	@ 0V, 1MHz C pF
PAM02SD2303C	3C	3.3	4.0	7.0	5	3
PAM02SD2305C	5C	5.0	6.0	9.8	5	3
PAM02SD2308C	8C	8.0	8.5	13.4	2	3
PAM02SD2312	2	12.0	13.3	19.0	1	3
PAM02SD2312C	2C	12.0	13.3	19.0	1	3
PAM02SD2315C	6C	15.0	16.7	24.0	1	3
PAM02SD2318C	1C	18.0	20.0	29.0	1	3
PAM02SD2324C	4C	24.0	26.7	43.0	1	3

TYPICAL DEVICE CHARACTERISTICS

FIGURE 1
PEAK PULSE POWER VS PULSE TIME

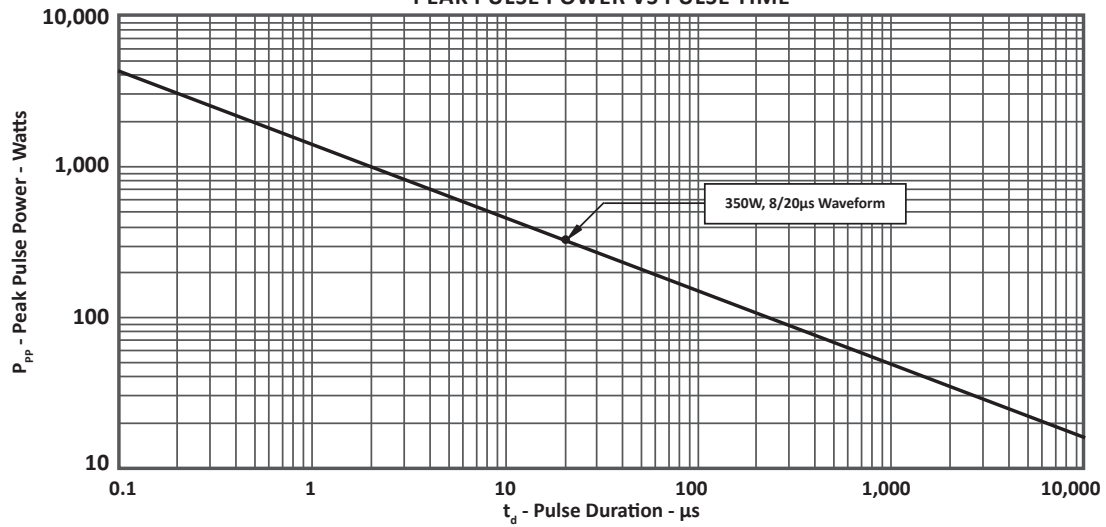
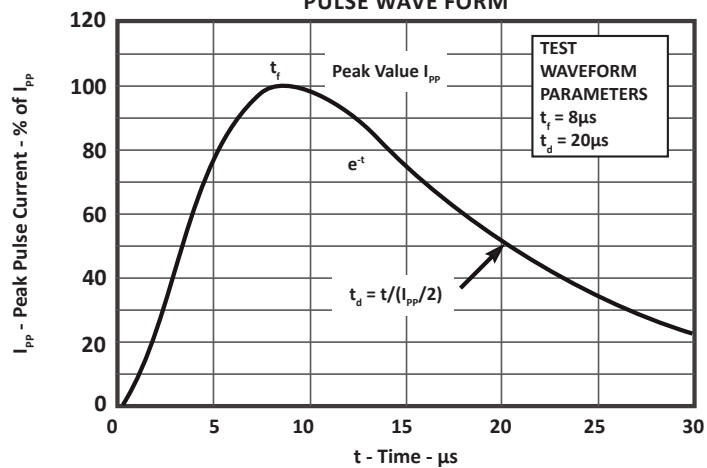
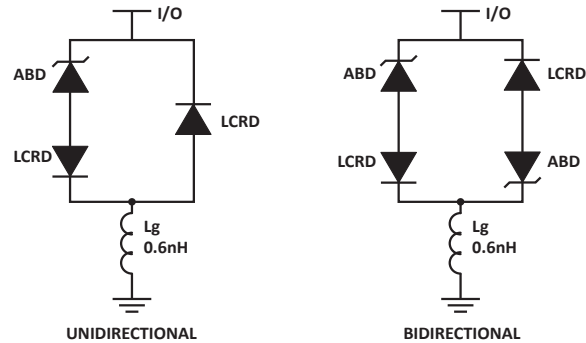

FIGURE 2
PULSE WAVE FORM



SPICE MODEL

FIGURE 1
SPICE MODEL

ABD - Avalanche Breakdown Diode (TVS)
 LCRD: Low Capacitance Rectifier Diode
 Lg - Lead Inductance

TABLE 1 - SPICE PARAMETERS

PARAMETER	UNIT	ABD(TVS)	LCRD
BV	V	See Table 2	200
IBV	μA	1	0.01
C _{jo}	pF	See Table 2	2
I _s	A	See Table 2	1E-11
Vj	V	0.6	0.6
M	-	0.33	0.33
N	-	1	1
R _s	Ohms	See Table 2	0.75
TT	s	1E-8	1E-9
EG	eV	1.11	1.11

TABLE 2 - ABD SPECIFIC SPICE PARAMETERS

PART NUMBER	B _v (VOLTS)	C _{jo} (pF)	I _s (AMPS)	Rs(OHMS)
PAM02SD2303C	4.0	438	1E-11	0.21
PAM02SD2305C	6.0	284	1E-11	0.14
PAM02SD2308C	8.5	146	1E-11	0.28
PAM02SD2312/12C	13.3	123	1E-13	0.40
PAM02SD2315C	16.7	102	1E-13	0.52
PAM02SD2318C	20.0	80	1E-13	0.80
PAM02SD2324C	26.7	61	1E-13	1.54

SOD-323 PACKAGE INFORMATION

OUTLINE DIMENSIONS

DIM	MILLIMETERS		INCHES	
	MIN	MAX	MIN	MAX
A	1.60	1.90	0.063	0.075
B	1.15	1.45	0.045	0.057
C	2.39	2.70	0.094	0.106
D	0.80	1.10	0.031	0.043
E	0.25	0.40	0.010	0.016
F	0.10	0.20	0.004	0.008
H	-	0.10	-	0.004
L	0.20	-	0.008	-

NOTES

- Controlling dimension: millimeters.
- Dimensioning and tolerances per ANSI Y14.5M, 1985.
- Dimensions are exclusive of mold flash and metal burrs.

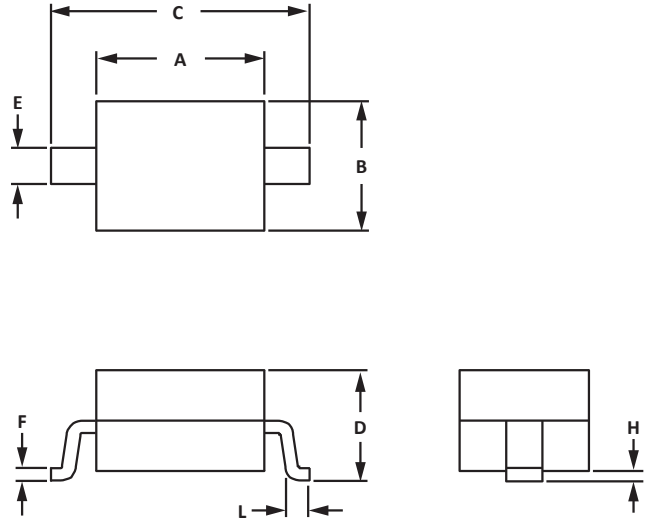

PAD LAYOUT DIMENSIONS

DIM	MILLIMETERS		INCHES	
	MIN	MAX	MIN	MAX
A	2.87	3.12	0.113	0.123
B	0.66	0.91	0.026	0.036
C	0.66	0.91	0.026	0.036

NOTES

- Controlling dimension: millimeters.

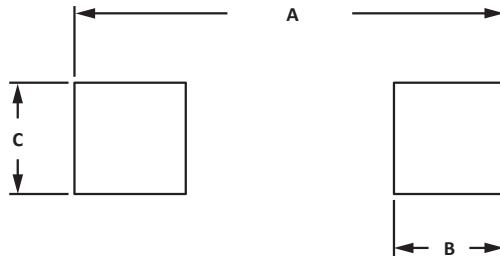

TAPE AND REEL

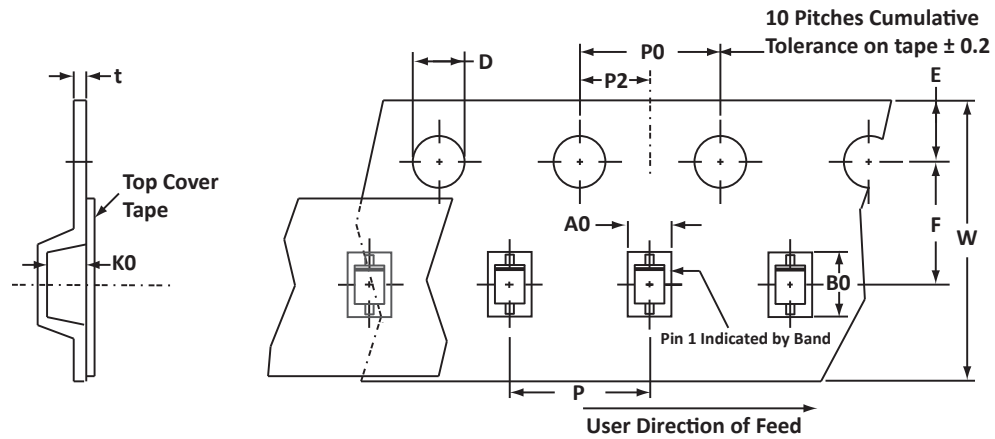

SPECIFICATIONS

REEL DIA.	TAPE WIDTH	A0	B0	K0	D	E	F	W	P0	P2	P	tmax
178mm (7")	8mm	1.55 ± 0.10	2.90 ± 0.10	1.35 ± 0.10	1.50 ± 0.10	1.75 ± 0.10	3.50 ± 0.05	8.00 ± 0.30	4.00 ± 0.10	2.00 ± 0.05	4.00 ± 0.10	0.25

NOTES

- Dimensions are in millimeters.
- Surface mount product is taped and reeled in accordance with EIA-481.
- Suffix - T7 = 7" Reel - 3,000 pieces per 8mm tape.
- Marking on Part - marking code (see page 2) and polarity band.

ORDERING INFORMATION

BASE PART NUMBER (xx = Voltage)	LEADFREE SUFFIX	TAPE SUFFIX	QTY/REEL	REEL SIZE	TUBE QTY
PAM02SD23xx/C	n/a	-T7	3,000	7"	n/a

This device is only available in a Lead-Free configuration.

COMPANY INFORMATION

COMPANY PROFILE

In business more than 25 years, ProTek Devices™ is a privately held semiconductor company. The company offers a product line of overvoltage protection and overcurrent protection components. These include transient voltage suppressor array (TVS arrays) avalanche breakdown diode, steering diode TVS array and electronics SMD chip fuses. These components deliver circuit protection in electronic systems from numerous overvoltage and overcurrent events. They include lightning; electrostatic discharge (ESD); nuclear electromagnetic pulses (NEMP); inductive switching; and electromagnetic interference (EMI) / radio frequency interference (RFI). ProTek Devices also offers LED wafer die for ESD protection and related high frequency products. ProTek Devices is ISO 9001:2015 certified.

CONTACT US

Corporate Headquarters

2929 South Fair Lane
Tempe, Arizona 85282
USA

By Telephone

General: 602-431-8101
Sales: & Marketing: 602-414-5109
Customer Service: 602-414-5114
Product Technical Support: 602-414-5107

By Fax

General: 602-431-2288

By E-mail:

Asia Sales: asiasales@protekdevices.com
Europe Sales: europesales@protekdevices.com
U.S. Sales: ussales@protekdevices.com
Distributor Sales: distysales@protekdevices.com
Customer Service: service@protekdevices.com
Technical Support: support@protekdevices.com

ProTek Devices (Asia Pacific) Pte. Ltd.

8 Ubi Road 2, #06-19
Zervex
Singapore - 408538
Tel: +65-67488312
Fax: +65-67488313

Web

www.protekdevices.com

COPYRIGHT © ProTek Devices 2014 - This literature is subject to all applicable copyright laws and is not for resale in any manner.

SPECIFICATIONS: ProTek reserves the right to change the electrical and or mechanical characteristics described herein without notice.

DESIGN CHANGES: ProTek reserves the right to discontinue product lines without notice and that the final judgement concerning selection and specifications is the buyer's and that in furnishing engineering and technical assistance. ProTek assumes no responsibility with respect to the selection or specifications of such products. ProTek makes no warranty, representation or guarantee regarding the suitability of its products for any particular purpose, nor does ProTek assume any liability arising out of the application or use of any product or circuit and specifically disclaims any and all liability without limitation special, consequential or incidental damages.

LIFE SUPPORT POLICY: ProTek Devices products are not authorized for use in life support systems without written consent from the factory.