

LOW CAPACITANCE TVS ARRAY



DESCRIPTION

The PESD12ULC is a low capacitance TVS array that is designed to protect components from damage or upset due to electrostatic discharge (ESD). The device is offered in a unidirectional configuration and is available in two lead DFN-0603 package. The PESD12ULC features a large cross sectional area junction for conducting high transient currents, fast response time and low operating voltage. This device meets the IEC 61000-4-2 and IEC 61000-4 requirements.

FEATURES

- Compatible with IEC 61000-4-2 (ESD): Air $\pm 30\text{kV}$, Contact $\pm 30\text{kV}$
- Compatible with IEC 61000-4-4 (EFT): 40A, 5/50ns
- 70 Watts Peak Pulse Power per Line ($t_p = 8/20\mu\text{s}$)
- Unidirectional Configuration
- Protects 1 Data Line
- Low Clamping Voltage
- Easy Placement for Manufacturing
- Replacement for MLV (0402)
- Fast Response Time: $< 1\text{ns}$
- RoHS Compliant
- REACH Compliant

APPLICATIONS

- Cellular Phones
- Portable Devices
- Digital Cameras
- Power Supplies

MECHANICAL CHARACTERISTICS

- Molded DFN-0603-2L Package
- Approximate Weight: 0.8 milligrams
- Lead-Free Plating: 100% Matte Sn(Tin)
- Solder Reflow Temperature - $260\text{-}270^\circ\text{C}$
- 8mm Tape and Reel Per EIA Standard 481
- Meets MSL 1 Requirements
- Flammability Rating UL 94V-0

PIN CONFIGURATION



TYPICAL DEVICE CHARACTERISTICS
MAXIMUM RATINGS @ 25°C Unless Otherwise Specified

PARAMETER	SYMBOL	VALUE	UNITS
Storage Temperature	T_{STG}	-55 to 150	°C
Junction Temperature	T_J	-55 to 150	°C
Peak Pulse Power ($t_p = 8/20\mu s$) - See Figure 1	P_{PP}	70	Watts

ELECTRICAL CHARACTERISTICS PER LINE @ 25°C Unless Otherwise Specified

PART NUMBER	DEVICE MARKING	RATED STAND-OFF VOLTAGE	TYPICAL BREAKDOWN VOLTAGE	MAXIMUM CLAMPING VOLTAGE (Fig. 2)	MAXIMUM CLAMPING VOLTAGE (Fig. 2)	MAXIMUM LEAKAGE CURRENT	TYPICAL CAPACITANCE
		V_{WM} VOLTS	@ 1mA $V_{(BR)}$ VOLTS	@ IP = 2A V_C VOLTS	@ IP = 3.5A V_C VOLTS	@ 12V I_D μA	@ 0V, 1MHz C pF
PESD12ULC	M	12.0	14.5	20.5	23.0	1.0	15.5

FIGURE 1
PEAK PULSE POWER VS PULSE TIME

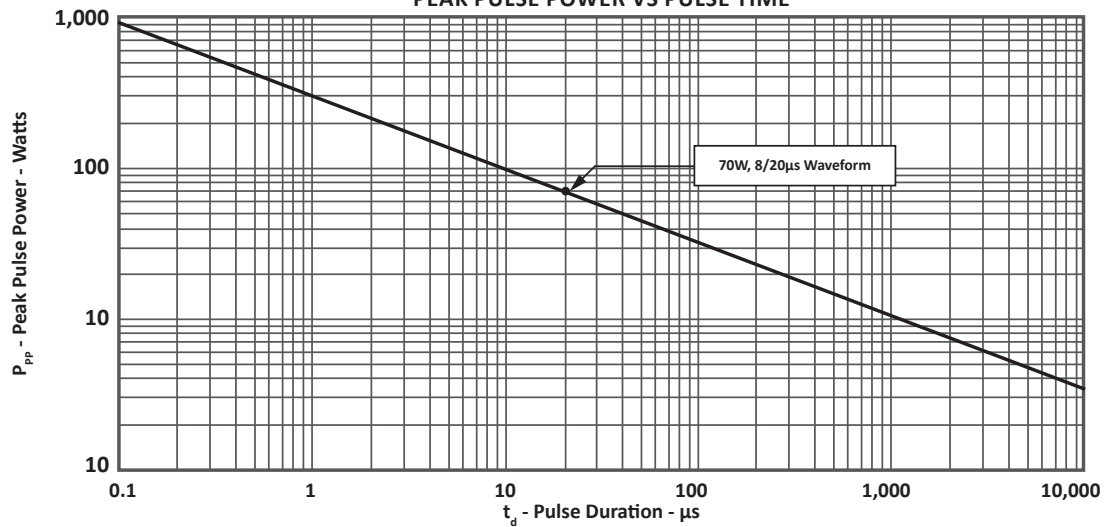

TYPICAL DEVICE CHARACTERISTICS

FIGURE 2
PULSE WAVE FORM

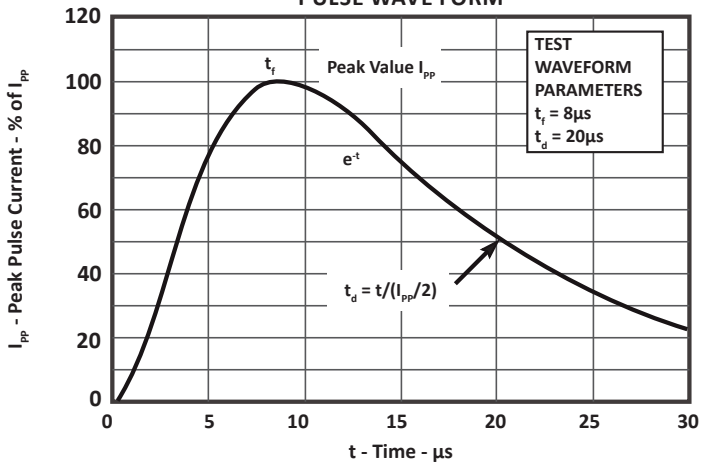
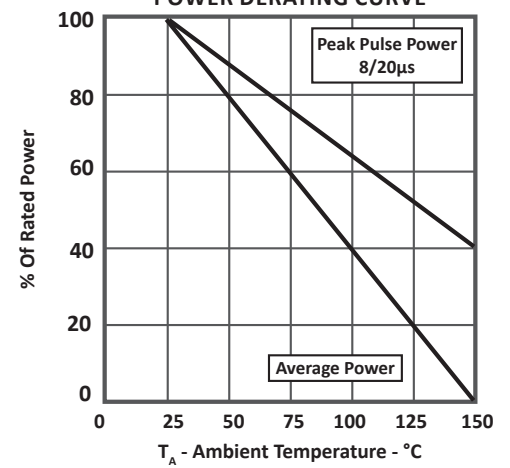
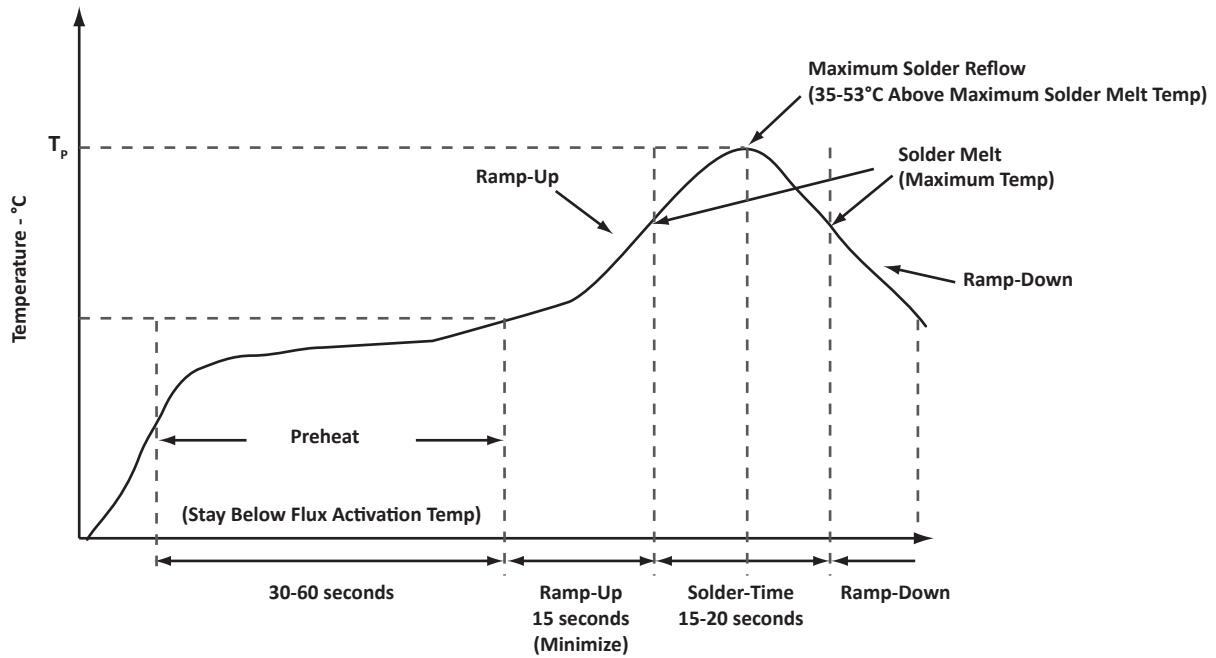

FIGURE 3
POWER DERATING CURVE



PACKAGE INFORMATION

PACKAGE INFORMATION
OUTLINE DIMENSIONS

DIM	MILLIMETERS		INCHES	
	MIN	MAX	MIN	MAX
A	0.290	0.325	0.011	0.013
B	0.210	0.270	0.007	0.011
D	0.570	0.630	0.022	0.025
E	0.270	0.330	0.011	0.014
F	0.140	0.200	0.006	0.008
G	0.015	0.045	0.0005	0.002
H	0.030	0.060	0.001	0.003
J	0.140	0.200	0.006	0.008

NOTES

1. Dimensioning and tolerances per ANSI Y14.M, 1985.
2. Controlling dimension: inches.

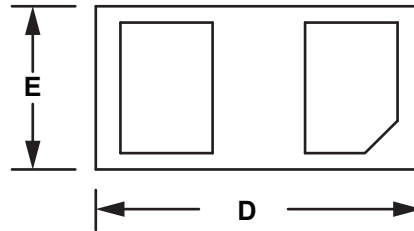
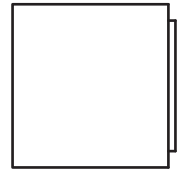
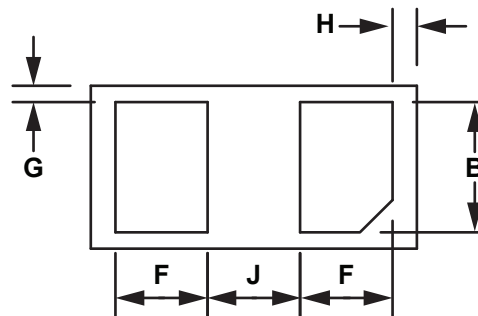
TOP VIEW

SIDE VIEW

BOTTOM VIEW

PAD LAYOUT DIMENSIONS

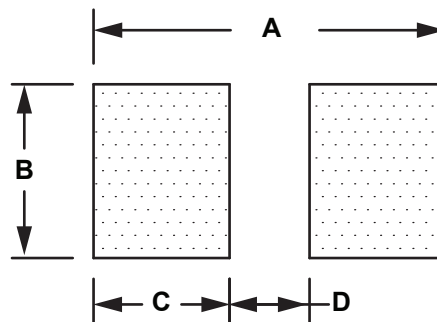
DIM	MILLIMETERS	INCHES
	NOM	NOM
A	0.650	0.025
B	0.320	0.013
C	0.250	0.010
D	0.150	0.006

NOTES

1. Decimal tolerances for mounting pad: $\pm 0.003''$ (± 0.08 mm).



TAPE AND REEL

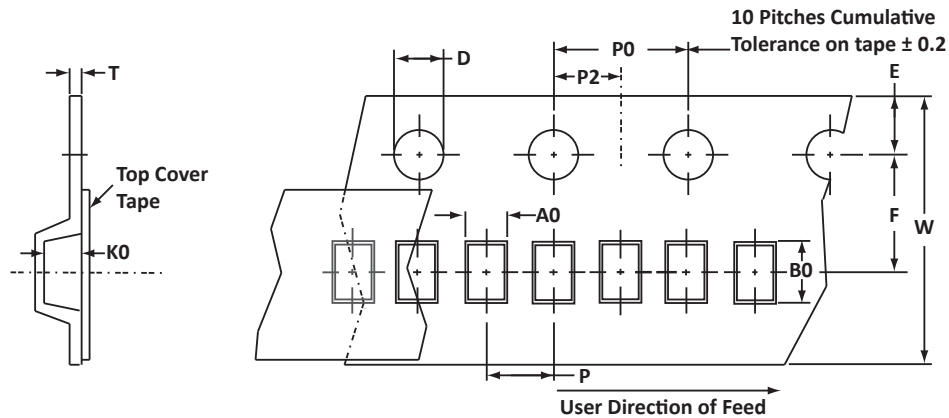

SPECIFICATIONS

REEL DIA.	TAPE WIDTH	A0	B0	K0	D	E	F	W	P0	P2	P	tmax
178mm (7")	8mm	TBD	TBD	TBD	1.55 ± 0.10	1.75 ± 0.10	3.50 ± 0.05	8.00 ± 0.30	4.00 ± 0.10	2.00 ± 0.05	2.00 ± 0.05	0.25

NOTES

- Dimensions are in millimeters.
- Surface mount product is taped and reeled in accordance with EIA-481.
- Suffix - T710 = 7" Reel - 10,000 pieces per 8mm tape.
- Marking on Part - marking code (see page 2).

ORDERING INFORMATION

BASE PART NUMBER	LEADFREE SUFFIX	TAPE SUFFIX	QTY/REEL	REEL SIZE	TUBE QTY
PESD12ULC	N/A	-T710	10,000	7"	N/A

This device is only available in a Lead-Free configuration.

COMPANY INFORMATION

COMPANY PROFILE

In business more than 20 years, ProTek Devices™ is a privately held semiconductor company. The company offers a product line of overvoltage protection and overcurrent protection components. These include transient voltage suppressor array (TVS arrays) avalanche breakdown diode, steering diode TVS array and electronics SMD chip fuses. These components deliver circuit protection in electronic systems from numerous overvoltage and overcurrent events. They include lightning; electrostatic discharge (ESD); nuclear electromagnetic pulses (NEMP); inductive switching; and electromagnetic interference (EMI) / radio frequency interference (RFI). ProTek Devices also offers LED wafer die for ESD protection and related high frequency products.

CONTACT US

Corporate Headquarters

2929 South Fair Lane
Tempe, Arizona 85282
USA

By Telephone

General: 602-431-8101
Sales: & Marketing: 602-414-5109
Customer Service: 602-414-5114
Product Technical Support: 602-414-5107

By Fax

General: 602-431-2288

By E-mail:

Asia Sales: asiasales@protekdevices.com
Europe Sales: europesales@protekdevices.com
U.S. Sales: ussales@protekdevices.com
Distributor Sales: distysales@protekdevices.com
Customer Service: service@protekdevices.com
Technical Support: support@protekdevices.com

ProTek Devices (Asia Pacific) Pte. Ltd.

8 Ubi Road 2, #06-19
Zervex
Singapore - 408538
Tel: +65-67488312
Fax: +65-67488313

Web

www.protekdevices.com

COPYRIGHT © ProTek Devices 2017 - This literature is subject to all applicable copyright laws and is not for resale in any manner.

SPECIFICATIONS: ProTek reserves the right to change the electrical and or mechanical characteristics described herein without notice.

DESIGN CHANGES: ProTek reserves the right to discontinue product lines without notice and that the final judgement concerning selection and specifications is the buyer's and that in furnishing engineering and technical assistance. ProTek assumes no responsibility with respect to the selection or specifications of such products. ProTek makes no warranty, representation or guarantee regarding the suitability of its products for any particular purpose, nor does ProTek assume any liability arising out of the application or use of any product or circuit and specifically disclaims any and all liability without limitation special, consequential or incidental damages.

LIFE SUPPORT POLICY: ProTek Devices products are not authorized for use in life support systems without written consent from the factory.