

## ULTRA LOW CAPACITANCE STEERING DIODE/TVS ARRAY



### DESCRIPTION

The PLR0504F is subminiature, ultra low capacitance steering diode/TVS suppressor array designed for the protection of sensitive IC components from the damaging effects of Electrostatic Discharge (ESD) and Electrical Fast Transients (EFT). This device is ideally suited for use in portable electronics such as SMART phones, laptops, and other wireless devices as well as gigabit Ethernet applications.

The PLR0504F provides protection in accordance with IEC 61000-4-2 and IEC 61000-4-4 requirements. This device is available in a SC70-6L package configuration and is rated at 200 Watts peak pulse power (8/20 $\mu$ s) per line.

### FEATURES

- Compatible with IEC 61000-4-2 (ESD): Air 15kV, Contact 8kV
- Compatible with IEC 61000-4-4 (EFT): 40A, 5/50ns
- 200 Watts Peak Pulse Power per Line(tp = 8/20 $\mu$ s)
- ESD Protection > 25 kilovolts
- Protects 4 Data Lines
- Low Clamping Voltage
- Ultra Low Capacitance: 1.9pF Typical
- RoHS Compliant
- REACH Compliant

### APPLICATIONS

- SMART Phones
- Portable Electronics
- Gigabit Ethernet
- USB 2.0, DVI, & Video Card Interfaces

### MECHANICAL CHARACTERISTICS

- Molded JEDEC SC70-6L Package
- Approximate Weight: 7milligrams
- Lead-Free Nickel Paladium Gold Plating
- Solder Reflow Temperature: 260-270°C
- Flammability Rating UL 94V-0
- 8mm Tape and Reel per EIA Standard 481

### PIN CONFIGURATION

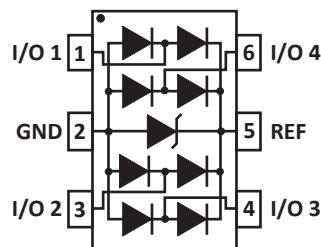

**TYPICAL DEVICE CHARACTERISTICS**
**MAXIMUM RATINGS @ 25°C Unless Otherwise Specified**

PARAMETER	SYMBOL	VALUE	UNITS
Peak Pulse Power ( $t_p = 8/20\mu s$ ) - See Figure 1	$P_{PP}$	200	Watts
Operating Temperature	$T_L$	-55 to 150	°C
Storage Temperature	$T_{STG}$	-55 to 150	°C
Forward Surge Rating (1/120 seconds @ 25°C, $I_F = 10mA$ )	$V_F$	1.5	Volts

**ELECTRICAL CHARACTERISTICS PER LINE @ 25°C Unless Otherwise Specified**

PART NUMBER	DEVICE MARKING	RATED STAND-OFF VOLTAGE (Note 1)  $V_{WM}$ VOLTS	MINIMUM BREAKDOWN VOLTAGE (Note 1)  @ 1mA $V_{(BR)}$ VOLTS	MAXIMUM CLAMPING VOLTAGE (Fig. 2) (Note 1) @ $I_p = 1A$ $V_C$ VOLTS	MAXIMUM CLAMPING VOLTAGE (Fig. 2) (Note 1) @ $I_p = 5A$ $V_C$ VOLTS	MAXIMUM LEAKAGE CURRENT (Note 1)  @ $V_{WM}$ $I_D$ $\mu A$	MAXIMUM CAPACITANCE (Note 1)  @ 0V, 1MHz $C_{j(SD)}$ pF
PLR0504F	A5	5.0	6.0	15.0	25.0	3	1.9

**NOTES**

- From I/O pin to ground.

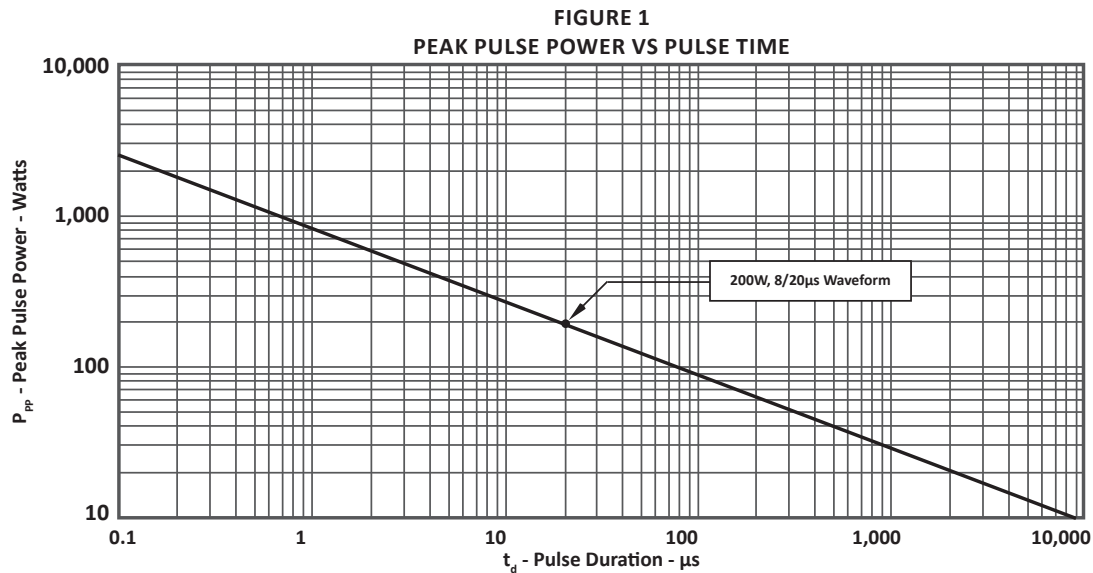

TYPICAL DEVICE CHARACTERISTICS

**FIGURE 2**  
PULSE WAVE FORM

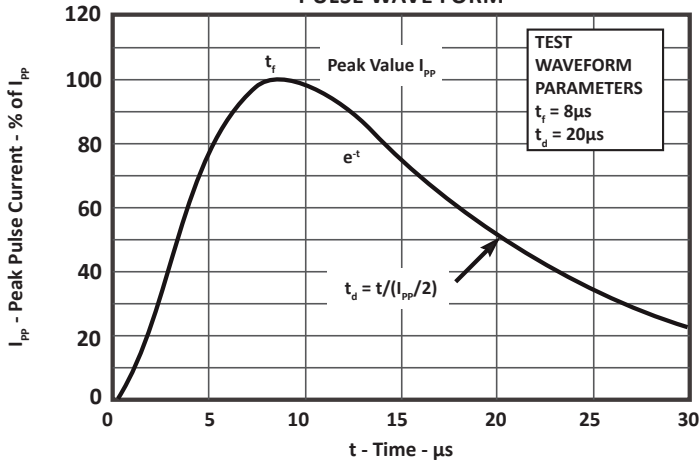

**FIGURE 3**  
POWER DERATING CURVE

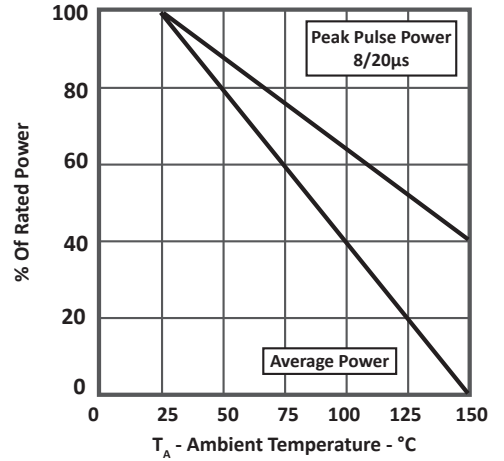

**FIGURE 4**  
OVERSHOOT & CLAMPING VOLTAGE

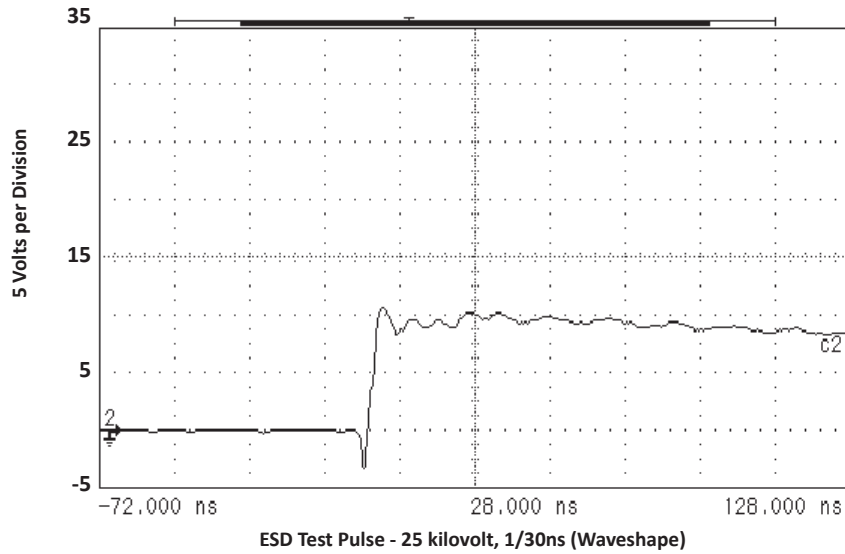

## SC70-6L PACKAGE INFORMATION

## OUTLINE DIMENSIONS

DIM	MILLIMETERS		INCHES	
	MIN	MAX	MIN	MAX
A	1.90	2.15	0.074	0.084
B	1.15	1.35	0.045	0.055
C	0.80	1.00	0.031	0.040
D	0.15	0.30	0.005	0.012
E	0.65 BSC		0.026 BSC	
F	1.30 BSC		0.051 BSC	
G	0.80	1.10	0.031	0.043
J	0.08	0.25	0.003	0.010
K	2.00	2.40	0.078	0.095
L	-	0.10	-	0.004
M	0.26	0.46	0.010	0.018

## NOTES

- Controlling dimension: inches.
- Dimensioning and tolerances per ANSI Y14.5M, 1985.
- Dimensions are exclusive of mold flash and metal burrs.

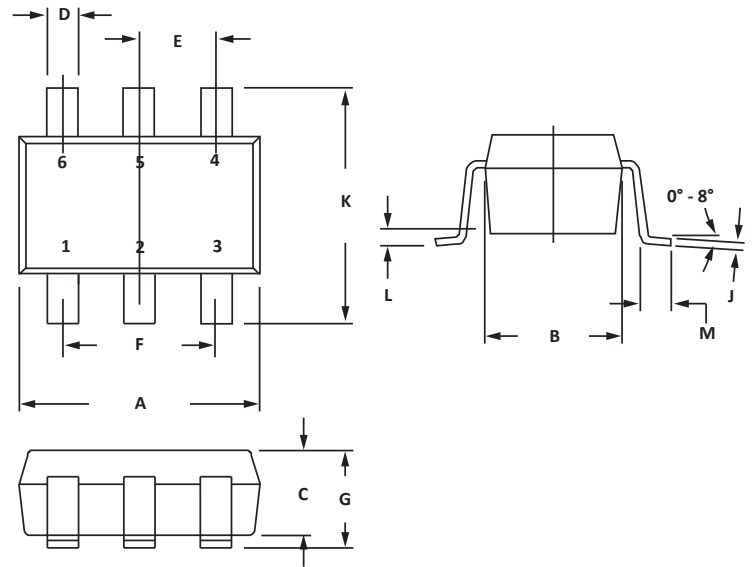

## PAD LAYOUT DIMENSIONS

DIM	MILLIMETERS	INCHES
	NOMINAL	NOMINAL
A	0.50	0.020
B	1.30	0.051
C	0.65	0.026
D	1.72	0.068
E	0.60	0.024

## NOTES

- Controlling dimension: inches.

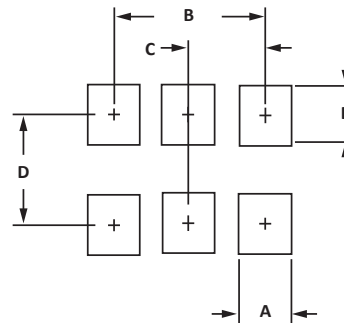

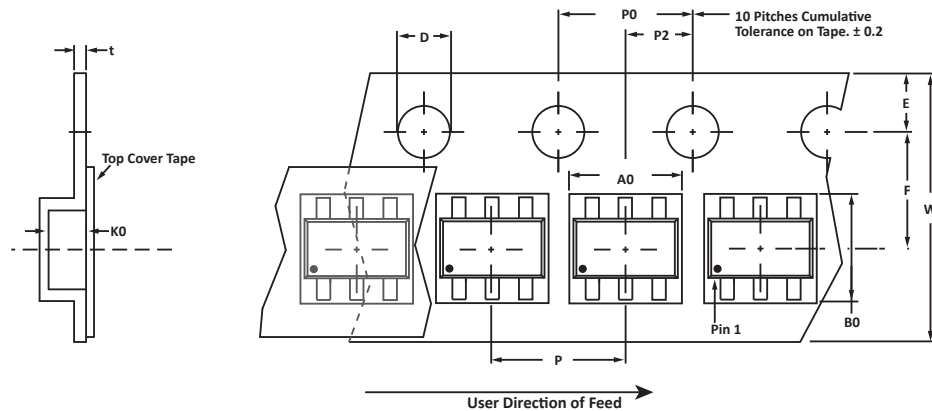
**TAPE AND REEL**

**SPECIFICATIONS**

REEL DIA.	TAPE WIDTH	A0	B0	K0	D	E	F	W	P0	P2	P	tmax
178mm (7")	8mm	2.25 ± 0.10	2.34 ± 0.10	1.22 ± 0.10	1.50 ± 0.10	1.75 ± 0.10	3.50 ± 0.05	8.00 ± 0.30	4.00 ± 0.10	2.00 ± 0.05	4.00 ± 0.10	0.25

**NOTES**

- Dimensions are in millimeters.
- Surface mount product is taped and reeled in accordance with EIA-481.
- Suffix - T73 = 7" Reel - 3,000 pieces per 8mm tape.
- Marking on Part - marking code (see page 2) and pin one defined by dot on package.

Package outline, pad layout and tape specifications per document number 06019.R5 3/11.

**ORDERING INFORMATION**

BASE PART NUMBER	LEADFREE SUFFIX	TAPE SUFFIX	QTY/REEL	REEL SIZE	TUBE QTY
PLR0504F	-P	-T73	3,000	7"	n/a

This device is only available in a Lead-Free configuration.

## COMPANY INFORMATION

---

### COMPANY PROFILE

In business more than 25 years, ProTek Devices™ is a privately held semiconductor company. The company offers a product line of overvoltage protection and overcurrent protection components. These include transient voltage suppressor array (TVS arrays) avalanche breakdown diode, steering diode TVS array and electronics SMD chip fuses. These components deliver circuit protection in electronic systems from numerous overvoltage and overcurrent events. They include lightning; electrostatic discharge (ESD); nuclear electromagnetic pulses (NEMP); inductive switching; and electromagnetic interference (EMI) / radio frequency interference (RFI). ProTek Devices also offers LED wafer die for ESD protection and related high frequency products. ProTek Devices is ISO 9001:2015 certified.

### CONTACT US

#### Corporate Headquarters

2929 South Fair Lane  
Tempe, Arizona 85282  
USA

#### By Telephone

General: 602-431-8101  
Sales: & Marketing: 602-414-5109  
Customer Service: 602-414-5114  
Product Technical Support: 602-414-5107

#### By Fax

General: 602-431-2288

#### By E-mail:

Asia Sales: [asiasales@protekdevices.com](mailto:asiasales@protekdevices.com)  
Europe Sales: [europesales@protekdevices.com](mailto:europesales@protekdevices.com)  
U.S. Sales: [ussales@protekdevices.com](mailto:ussales@protekdevices.com)  
Distributor Sales: [distysales@protekdevices.com](mailto:distysales@protekdevices.com)  
Customer Service: [service@protekdevices.com](mailto:service@protekdevices.com)  
Technical Support: [support@protekdevices.com](mailto:support@protekdevices.com)

#### ProTek Devices (Asia Pacific) Pte. Ltd.

8 Ubi Road 2, #06-19  
Zervex  
Singapore - 408538  
Tel: +65-67488312  
Fax: +65-67488313

#### Web

[www.protekdevices.com](http://www.protekdevices.com)

COPYRIGHT © ProTek Devices 2007 - This literature is subject to all applicable copyright laws and is not for resale in any manner.

SPECIFICATIONS: ProTek reserves the right to change the electrical and or mechanical characteristics described herein without notice.

DESIGN CHANGES: ProTek reserves the right to discontinue product lines without notice and that the final judgement concerning selection and specifications is the buyer's and that in furnishing engineering and technical assistance. ProTek assumes no responsibility with respect to the selection or specifications of such products. ProTek makes no warranty, representation or guarantee regarding the suitability of its products for any particular purpose, nor does ProTek assume any liability arising out of the application or use of any product or circuit and specifically disclaims any and all liability without limitation special, consequential or incidental damages.

LIFE SUPPORT POLICY: ProTek Devices products are not authorized for use in life support systems without written consent from the factory.